

LINEAR LIGHTS

JESSE SERIES  
DIRECT/INDIRECT SUSPENDED LINEAR LIGHT

KEY FEATURES

- Typical percentage output ratio 75 : 25
- Available in 3 standard lengths
- Delivering approx. 3000lm per meter as standard
- Coloured matched, injection moulded end caps
- TPa opal lens for feature, general and visual areas
- Low glare prismatic lens available for office and LG7 compliance
- Tridonic low energy LED and driver system
- Efficacy up to 130 lm/tcW
- Finished in RAL 9006 grey as standard

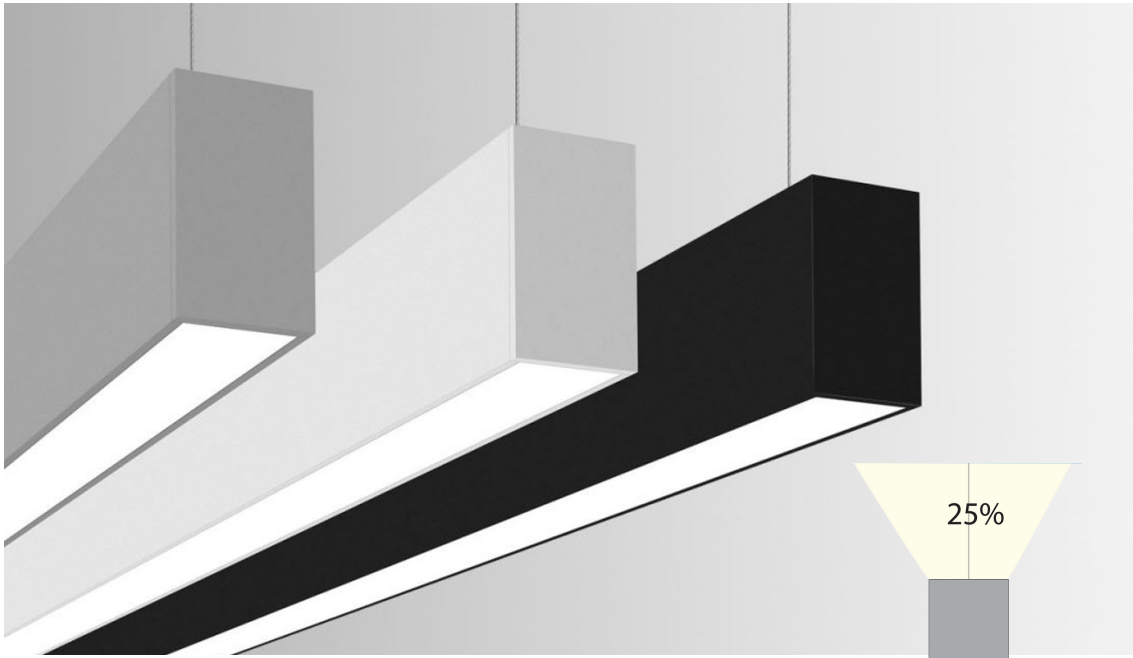

DIMENSIONS

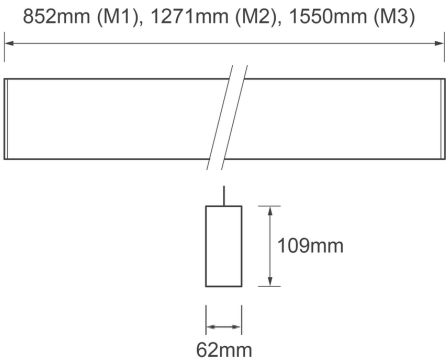

IP20   220-240V   OPT TEMP -25 to +35°C   50-60HZ   CRI 80   LIFETIME 72,000 HRS   3/5yrs warranty       CE   RoHS

TRIDONIC  
TECHNOLOGY  
INSIDE

Standard Warranty: 2 Years  
Extended Warranty: 3 Years

TECHNICAL SPECIFICATION

MODEL NUMBER	W	lm	K
	STD / LO / HO	STD / LO / HO	
NR-JESSE-M1	27W/19W/41W	2350lm/1600lm/3725lm	3,000K 4,000K
NR-JESSE-M2	38W/27W/59W	3525lm/2400lm/5600lm	
NR-JESSE-M3	47W/30W/76W	4550lm/3075lm/7225lm	

STD: STANDARD                      M1: 850MM | M2: 1.2M | M3: 1.5M  
LO: LOW OUTPUT  
HO: HIGHOUTPUT

Fabiia, G08, The Light Box, 111 Power Road, Chiswick, London W4 5PY, United Kingdom.  
contact@norse.lighting | www.norse.lighting

Please note: Specification values may change due to rapid development of lighting technology. Data may be rounded up/down for illustrative purposes. Tolerance range of optical and electrical data is +/-10%. We reserve the right to amend or change details without prior notification.

LINEAR LIGHTS

JESSE SERIES  
DIRECT/INDIRECT SUSPENDED LINEAR LIGHT

OPTIONS

WH / White body



BK / Black body

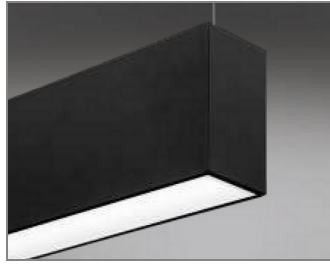

LO / Lower output

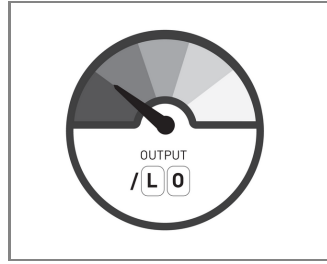

HO / Higher output

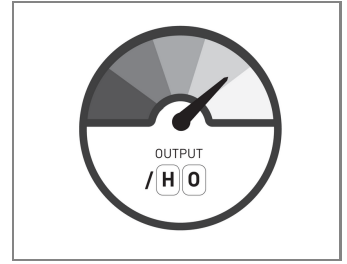

ECO / SwitchDIM,  
Dali or DSI

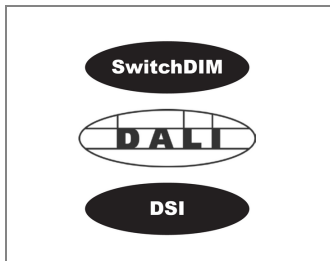

EMI / EM conversion



LG / Low glare  
prismatic lens

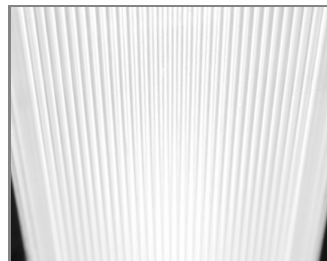

ALSO AVAILABLE

BU.180  
180deg butt joint bracket

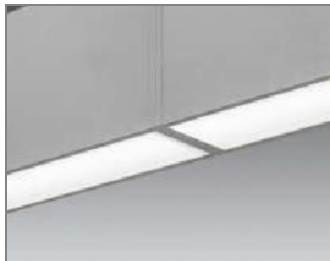

BU.90  
90deg butt joint bracket

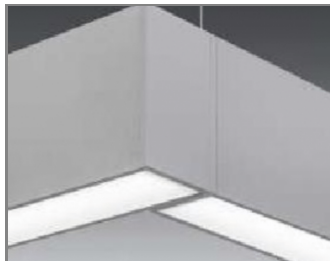

Product variations Other  
colours and specifications  
available on request



Product variations  
Custom body colours

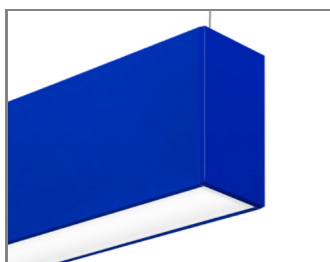

Product variations  
Custom colours

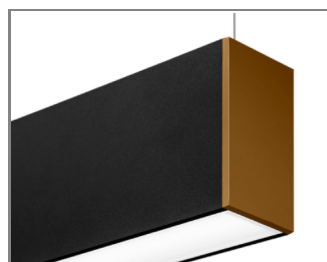

PT001  
Diffuser removal tool

